

	A	B	C	D	E	F	G	SERIES 2 L DRILL	
INCH	.327	1.109	.900	.350	2.250	3.106	6.188	MAXIMUM RECOMMENDED DRILL DIAMETER	.250 INCH
MM	8.30	28.16	22.86	8.89	57.15	78.89	157.1		6.35 mm

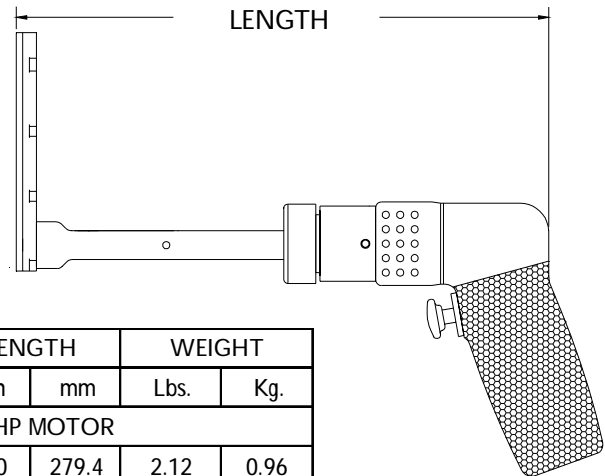

13823 ATTACHMENT ONLY EXTENDED

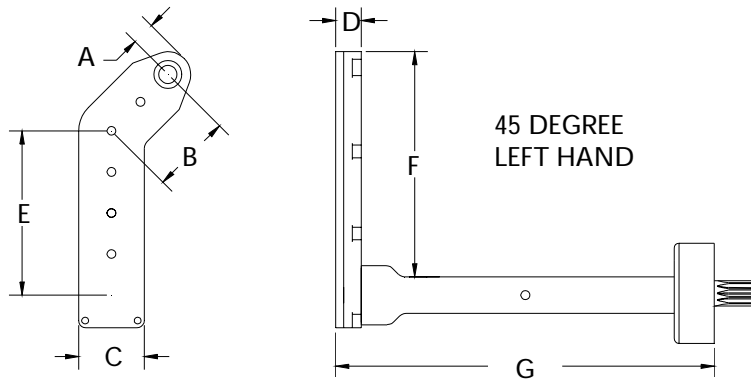

TOOL ORDER NUMBER	R.P.M.	LENGTH		WEIGHT	
		Inch	mm	Lbs.	Kg.
D SERIES .30 HP MOTOR					
16362	250	11.0	279.4	2.12	0.96
14528	500	11.0	279.4	2.12	0.96
14529	750	11.0	279.4	2.12	0.96
14530	1000	11.0	279.4	2.12	0.96
14531	1500	11.0	279.4	2.12	0.96
14532	2800	10.1	256.5	1.84	0.83
D2 SERIES .60 HP MOTOR					
16363	250	12.95	328.9	3.69	1.67
14533	450	12.35	313.6	2.99	1.35
14534	1000	12.35	313.6	2.99	1.35
14535	2000	11.10	281.9	2.74	1.24
14536	2700	11.10	281.9	2.74	1.24
14537	3500	11.10	281.9	2.74	1.24
RD2 .40 HP REVERSIBLE MOTOR					
16364	250	12.95	328.9	3.69	1.67
14538	450	12.35	313.6	3.24	1.46
14539	1000	12.35	313.6	3.24	1.46
14540	2000	11.10	281.9	2.99	1.35
14541	2700	11.10	281.9	2.99	1.35
14542	3500	11.10	281.9	2.99	1.35

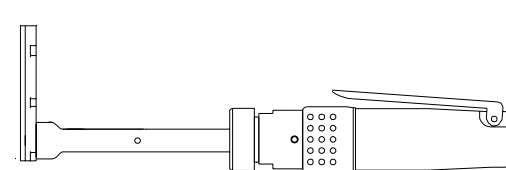

Add an S after the tool order number for the straight handle option.

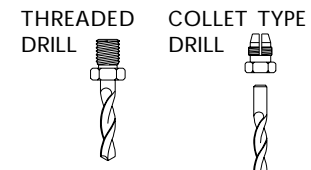

INTERNAL THREAD	
ADD TO TOOL No.	
1/4-28	A
10-32	C
9/32-40	E
5/16-24	F
COLLET	D

PHONE: 1 775 883 1072 FAX: 1 775 883 4857